

'u 'oU ° ku Mut'



User Guide

Contents

Unpacking the TV / Accessories	1
Installing / Removing the Base Stand	2
Front / Right Side View and Controls	3
Rear View and Sockets	4
Remote Control	5-6
Installing Batteries in the Remote Control	7
Remote Control Operation Range	7
Making Video and Audio Connections	8
Connecting an AV Device with an HDMI Cable	8
Connecting an AV Device with a Component (YPbPr) cable	9
Connecting an AV Device with Composite Cable	10
Connecting a Digital Audio Receiver	11
Connecting Headphones	11
Turning the TV on for the First Time	12-13
Channel Setting	14-17
Picture Setting	18-19
Sound Setting	20
Application Setting	21
Connecting a USB Storage Device	22
Multimedia Operation	23-25
Setting menu	26-33
Time Setting	26
Lock Setting	27-28
Option Setting	29
PC Setting	29
Network Setting	30-31
PVR (DTV Mode)	32-33
EPG(Electronic Programme Guide)(DTV Mode)	34
Teletext(ATV Mode)	35
Digital Teletext(DTV Mode)	35
Maintenance	36
Hints and Tips	36-37
Display Modes	38
Specifications	39
Safety Warnings	40-41

Thank you for purchasing your new 65" TV.

Your new TV has many features and incorporates the latest technology to enhance your viewing experience. We recommend that you spend some time reading this instruction manual in order that you fully understand these features. You will also find some hints and tips to help you resolve any issues.

Read all the safety instructions carefully before use and keep this instruction manual for future reference.

Unpacking the TV / Accessory's



TV set

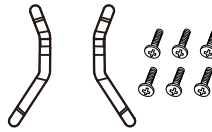

Base/ Screws
(M4 x18 6PCS)



Power Cable



Remote Control

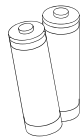

Batteries

Quick Start Guide

Warranty Card

Installing / Removing the Base Stand

The parts

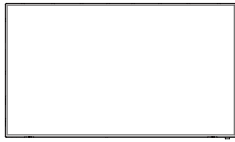

TV set

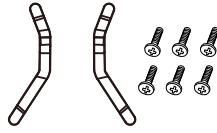

Base/ Screws
(M4 x18 6PCS)

Installation

Place the TV face down on a soft and flat surface (blanket, foam, cloth, etc.) to prevent any damage to the TV.

1. Attach the stand feet in the positions shown and secure them with supplied screws.

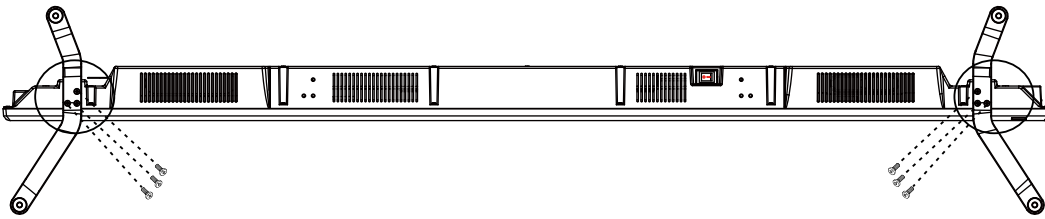

This unit is VESA-Compliant and designed to be wall mounted with a VESA-Compliant 400 x 400mm mounting kit.

Mount this unit according to the instructions of the wall bracket(not supplied)

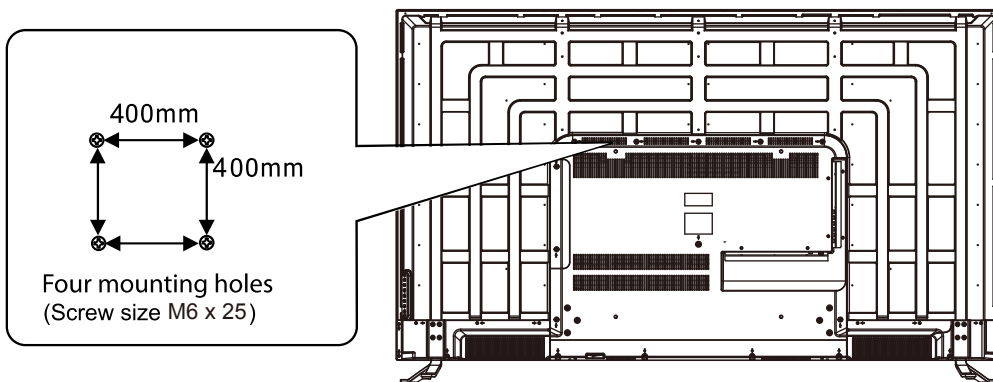

Front / Right Side View and Controls

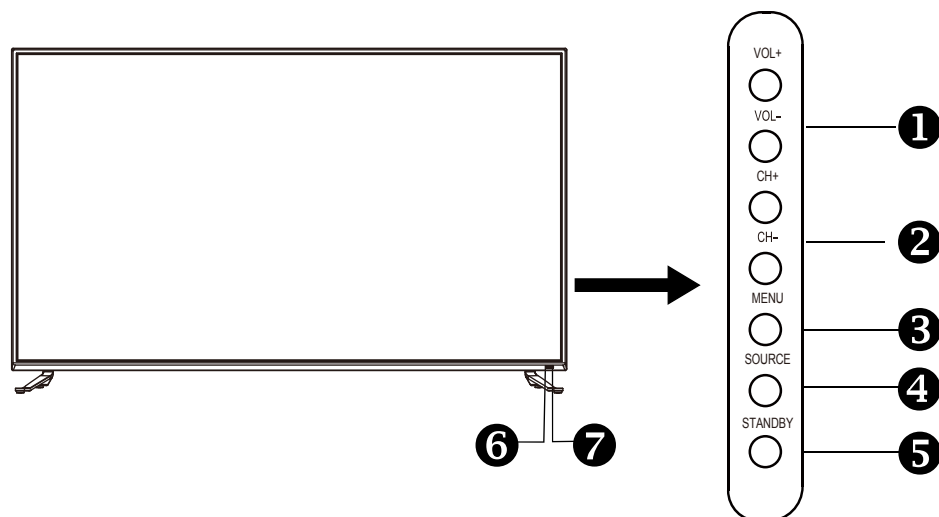

Button Name	Description
1 VOL+/-	Increase or decrease the volume. Adjust the volumes of the selected menu item in the OSD menu.
2 CH+/-	Press to select a channel or select a sub-menu from the OSD menu.
3 SOURCE	Press to select among different input signal sources: DTV / ATV / SCART / YPbPr / HDMI / AV / MEDIA . Confirmed the selection on OSD menu
4 MENU	Enter or exit from the menu.
5 STANDBY	Switch on the LED TV when at standby mode and vice versa.
6 Power Indicator	Illuminates red in standby mode. Illuminates green when the LED TV is switched on.
7 Remote Sensor	Infrared sensor for the remote control.

Rear View and Sockets

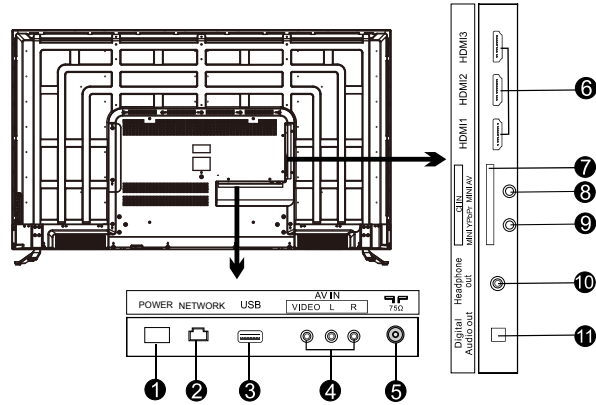

Socket	Description
1 POWER	#
2 NETWORK	To connect the broadband router.
3 USB	Allows the insertion of a USB storage device to play video, audio photo and text files (Media mode) and record DTV programmes on to a USB storage device.
4 AV IN	connect to the audio output terminal of a DVD player with AV/YPbPr mode
5 TV Aerial	To connect to the aerial socket on the wall with the RF coaxial cable.
6 HDMI IN	To connect to a High-Definition(HD)signal output device, such as a set-top box, blu-ray disc player or AV receiver.
7 CI (Common Interface)Slot	Allows the insertion of a Common Access Module.
8 MINI AV/AUDIO (L/R)	To connect to a DVD player, Digital Set-Top-Box, or other AV devices with composite (AV) video and audio output socket
9 MINI YPbPr	To connect to a DVD player, Digital Set-Top-Box, or other AV devices with component (YPbPr) video and audio output sockets.
10 Headphone out	To connect to the earphones.
11 DIGITAL AUDIO OUT (OPTICAL)	To connect to the audio socket on the digital/standard 5.1 audio system.

Remote Control

Dependant on the Model of the TV some keys will have no function

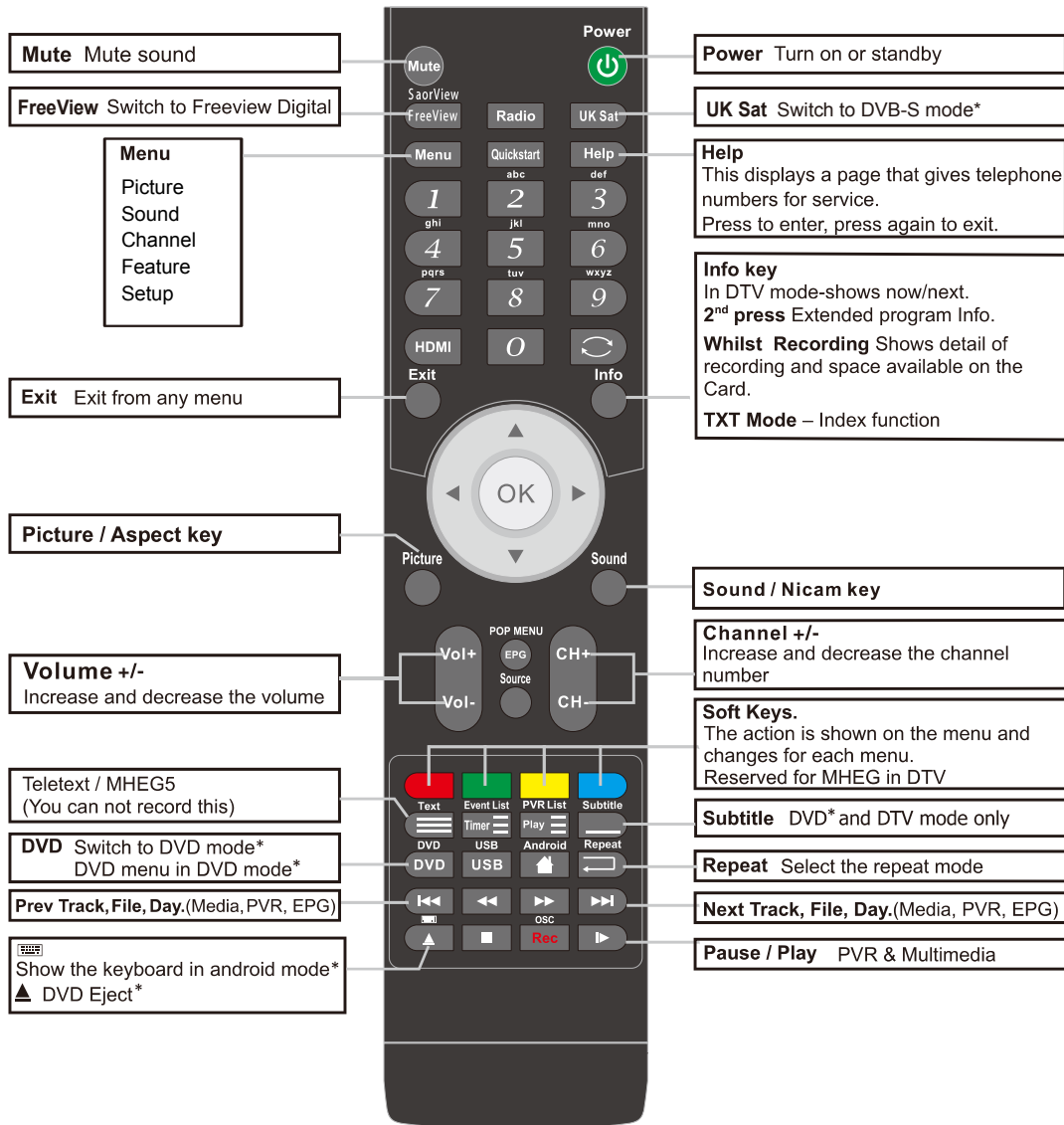

*Dependant on Model

Remote Control

■ Functions of remote control buttons

Dependant on the model of theTV some keys will have no function

■ Functions of remote control buttons

Dependant on the model of theTV some keys will have no function

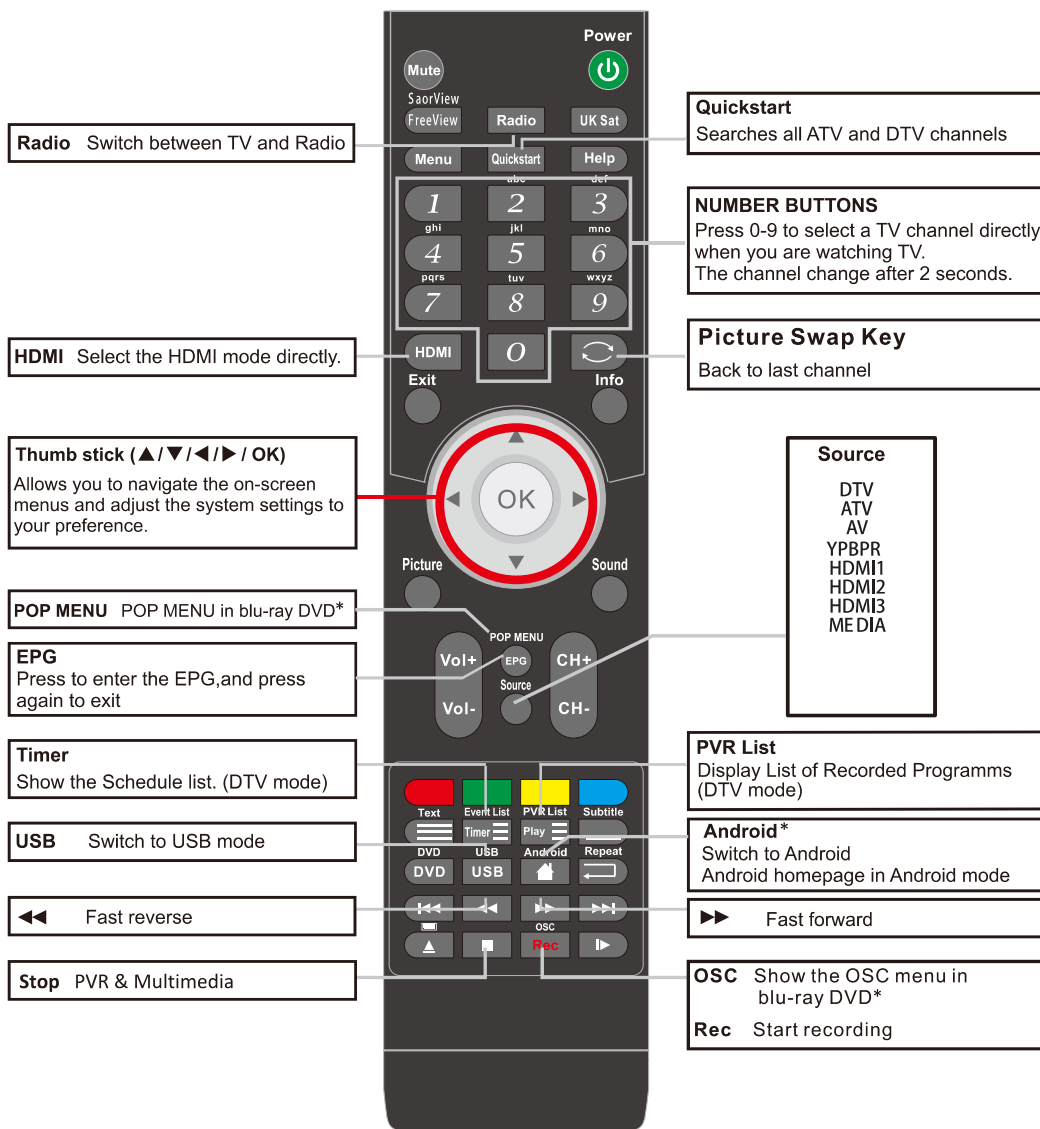

*Dependant on Model

Installing Batteries in the Remote Control

1. Press and lift the back cover to open the battery compartment of the remote control.
2. Insert two 1.5V AAA size batteries. Make sure to match the (+) and (-) ends of the batteries with the (+) and (-) ends indicated in the battery compartment.
3. Close the battery compartment cover.

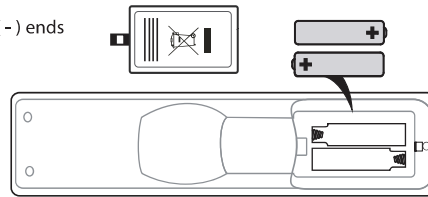

Handling the Batteries

- Improper or incorrect use of batteries may cause corrosion or battery leakage, which could cause fire, personal injury or damage to property.
- Only use the battery type indicated in this manual.
- When the batteries are exhausted, the remote will not function. Replace both batteries at the same time with new ones.
- Do not install new batteries with used ones and do not mix different types of batteries.
- Do not dispose of used batteries as domestic waste. Dispose of them in accordance with local regulations.



Handling the Remote Control

- Take care of your fingernails when you press and hold the battery release tab.
- Do not drop or cause impact to the remote control.
- Do not spill water or any liquid on the remote control.
- Do not place the remote control on a wet object.
- Do not place the remote control under direct sunlight or near sources of excessive heat.
- Remove the battery from the remote control when not in use for a long period of time, as it could cause corrosion or battery leakage and may result in physical injury and/or property damage including fire.

Remote Control Operation Range

Point the remote control at the TV no more than 5 metres from the remote control sensor on the TV and within 60° in front of the TV. The operating distance may vary depending on the brightness of the room.

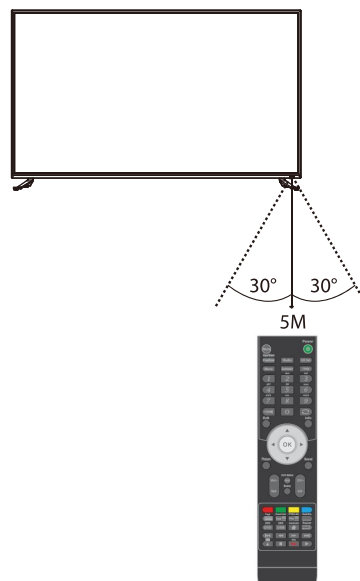





Remote Code:0156

To use your sky remote control with this TV follow the instructions given with the sky remote to programme different codes.

Making Video and Audio Connections



Not all AV devices have the ability to connect to a TV, please refer to the owner's manual of your AV device for compatibility and connection procedures.

When connecting any external AV device, do not connect the mains cable to the mains socket until all other connections are complete.

Best Video Performance ↑		Signal Type	Separate Audio Connection Required
	 HDMI	HDMI (480i/480p/576i/576p/720p/1080i/1080p)	No
	 Mini YPbPr	Component Video (480i/480p/576i/576p/720p/1080i/1080p)	Yes  Mini AV
	 Mini AV	Composite Video	No

Connecting an AV Device with an HDMI Cable

- This TV can accept High-Definition Multimedia Interface (HDMI) and supports HDCP (High-Bandwidth Digital Content Protection) Protocol.
- The TV has a total of 3 HDMI input sockets, please make sure the correct input source is selected corresponding to your connected HDMI input socket.
- When you connect to the output of an HD ready player (Blu-ray disc player, game console, set-top box or computer) switch to the HDMI function and the TV will automatically detect the resolution used by the HDMI source.
- To get the best picture quality, adjust the Blu-ray disc player, game console or set-top box output resolution up to 1920 x 1080p.

1. Use an HDMI cable to connect the TV's HDMI input socket to the external AV device's HDMI output socket.
2. Plug the connected devices into the mains socket
3. Press the **STANDBY** button on the TV or the  button on the remote control to turn on your TV.
4. Press the **SOURCE** button on the TV or the **SOURCE** button on the remote control to display the Source List. Use the   buttons to select **HDMI1/2/3** and then press the **OK** button to confirm.



Although this TV is able to connect to an HDMI device, it is possible that some devices may not operate correctly.

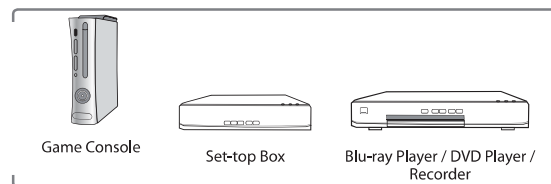
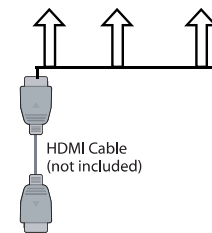

Connecting an AV Device with a Component (YPbPr) Cable

1. Use a component cable to connect the TV's Mini YPbPr input sockets to an external AV device's component output sockets.
2. Use an AV cable to connect the TV's Mini AV input sockets to the external AV device's component audio output sockets.
(Audio Left = white, and Audio Right = red)

Component port on the TV	Mini YPbPr		
Video output ports on DVD player	Y	Pb	Pr
	Y	Cb	Cr

3. Plug the connected devices into the mains socket
4. Press the **STANDBY** button on the TV or the **⏻** button on the remote control
5. Press the **SOURCE** button on the TV or the **SOURCE** button on the remote control to display the **Source List**. Use the **▲▼** buttons to select **YPbPr** and then Press the **OK** button to confirm.

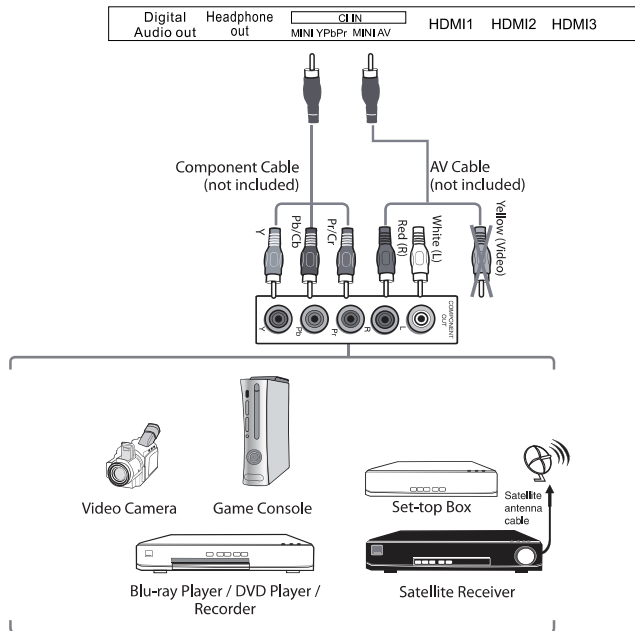

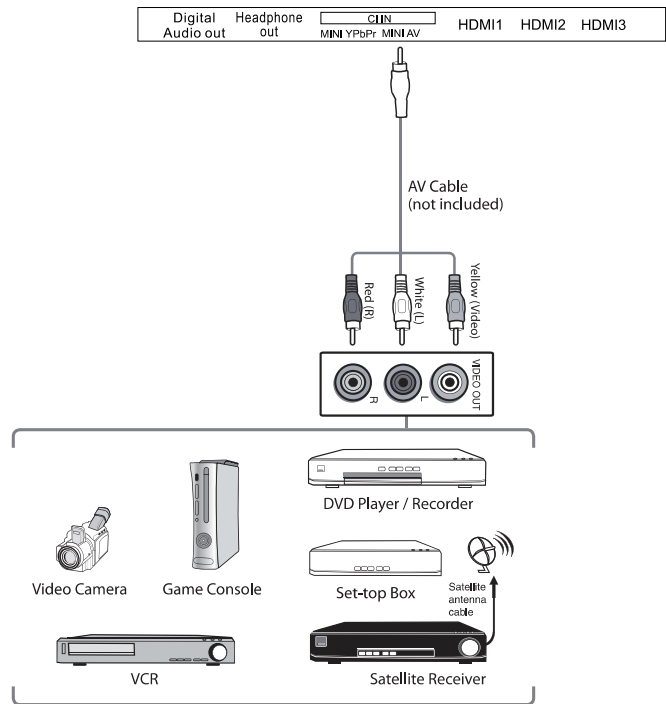

Connecting an AV Device with Composite Cable

1. Use an AV cable to connect the TV's Mini AV input sockets to an external AV device's composite audio/video sockets. (Video = yellow, Audio Left = white, and Audio Right = red)
2. Plug the connected devices into the mains socket
3. Press the **STANDBY** button on the TV or the **⏻** button on the remote control
4. Press the **SOURCE** button on the TV or the **SOURCE** button on the remote control to display the Source List. Use the **▲▼** buttons to select **AV** and then press the **OK** button to confirm.



Connecting a Digital Audio Receiver

For better sound quality, you may want to play the audio through your multi-channel audio receiver.

1. Use an audio cable to connect the TV's Digital Audio out socket to an external audio receiver's audio optical input socket.
2. Plug the connected devices into the mains socket
3. Press the **STANDBY** button on the TV or the  button on the remote control
4. Press the **SOURCE** button on the TV or the **SOURCE** button on the remote control to display the Source List. Use the   buttons to select any desired input source and then press the **OK** button to confirm.

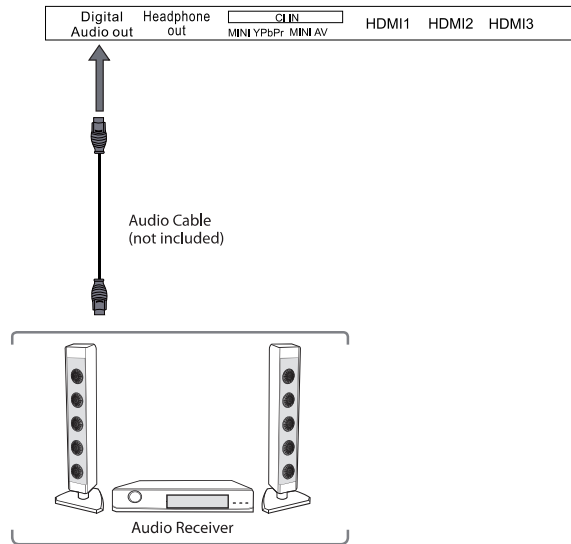

Connecting Headphones

Connect your headphones to the TV's Headphone out socket.

Before putting on headphones, turn the volume down then put the headphones on and slowly increase the volume until you reach a comfortable listening level.



Long-term exposure to loud music may cause hearing damage. It is best to avoid extreme volume when using earphones, especially for extended periods.

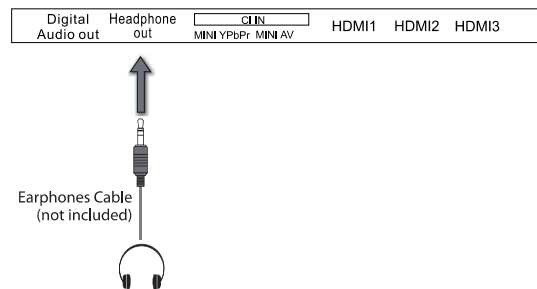

Turning the TV on for the First Time

1. Connect one end of the RF coaxial cable to the aerial socket on the wall and the other end of the cable to the Aerial socket at the rear bottom of your TV.



Do not connect the TV to the mains supply until you have completed all the connections.

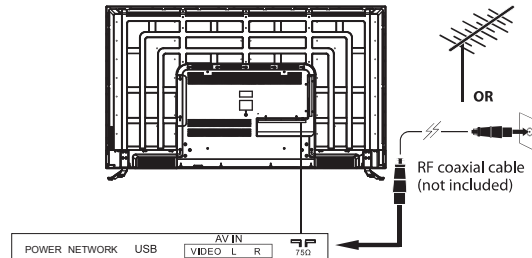



2. Connect the mains cable to the mains socket after you have completed all the connections.

3. At this stage, the TV switches to standby mode. The red LED indicator will illuminate on the front panel of the TV.

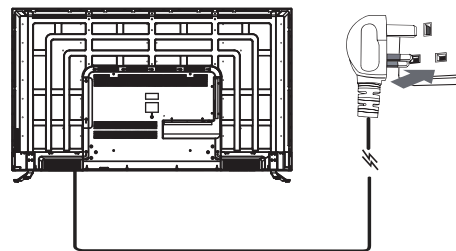
4. In standby mode, press the **STANDBY** button on the TV or the  button on the remote control to turn the TV on. The LED indicator will change from red to green.



- Always disconnect the TV from the mains socket when not in use for a long period of time.
- The **STANDBY** button on the TV or the  button on the remote control is only used for switching the TV into standby, it does not disconnect the TV from the mains power. To completely disconnect the mains power, please remove the mains cable from the mains socket.

1. Connect the adapter and the power cable to the AC power supply and the Aerial lead to the Aerial in (RF) socket.
2. Switch on the TV by pressing .
3. The 5 step "Quick Start" menu will appear on your screen. (Pictures below)
4. Select Languages, Country, Auto Power Off and TV Connection then press the  button to start the tuning process, This process will find all available channels and store them.

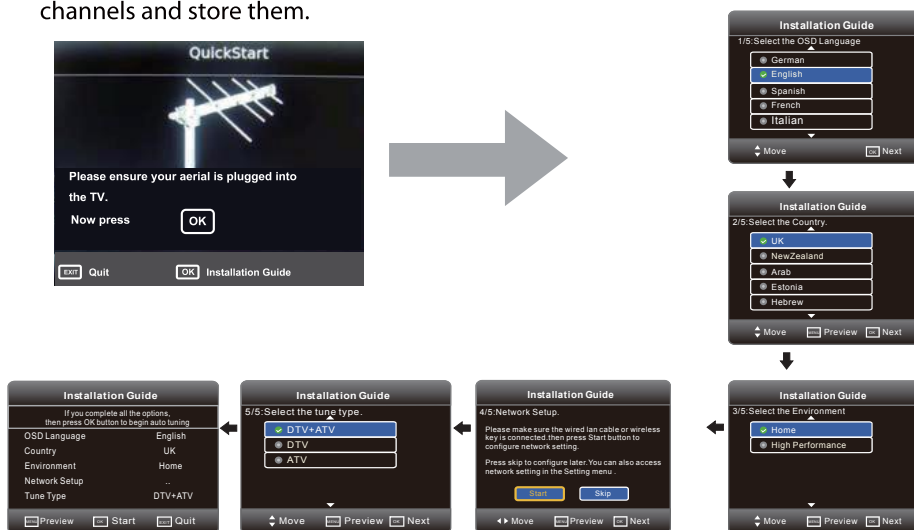

Turning the TV on for the First Time

Selecting the Input Source

1. Press the **Source** button on the TV or the **Source** button on the remote control to display the Input source list.
2. Press the **▲▼◀▶** buttons to select the input source that you want: DTV, ATV, AV, YPBPR, HDMI, Media.
3. Press the **OK** button to confirm your selection. If you do not press the **OK** button to confirm, the TV will automatically confirm the selected input source within 4 seconds.



In DTV mode, press the **Radio** button to switch to TV / digital radio channels directly.



Channel Selection

- Press the **CH+ / -** buttons on the TV or on the remote control repeatedly or the **0-9** buttons on the remote control to select the channel.



Alternative

Press the **OK** button to enter the **Channel List**. Then use the **▲▼** buttons to highlight and select the channel. Press the **OK** button to view the selected channel.

- If a blocked channel is selected, the password screen will be displayed. Press the **0-9** buttons to enter the password, the channel will then be unlocked (refer to page 22 for details on LOCK).
- Press the **↺** button to return to the previously viewed channel.

Display Channel Information

- Press the **Info** button to view the current information.

Volume Adjustment

- Press the **VOL+/-** button on the TV or on the remote control to adjust the volume.
- If you wish to switch the sound off, press the **Mute** button. Press the **Mute** button again or the **VOL+** button to resume audio listening.

Channel Setting (TV, DTV or Radio Mode)

1. Press the **Menu** button to select the **CHANNEL** menu .

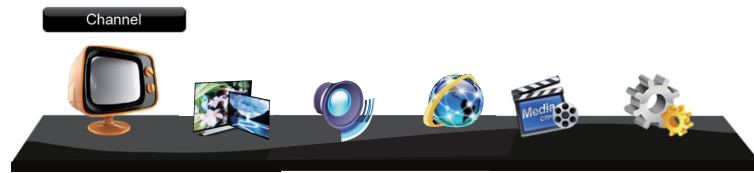

2. Press the **▲▼** buttons to select **Auto Tuning** and then press the **OK** button.

Auto Tuning (DTV / ATV mode)

Use this to automatically find and store all available channels. This is normally recommended if some channels have been added or removed by the broadcaster or if you have moved house.

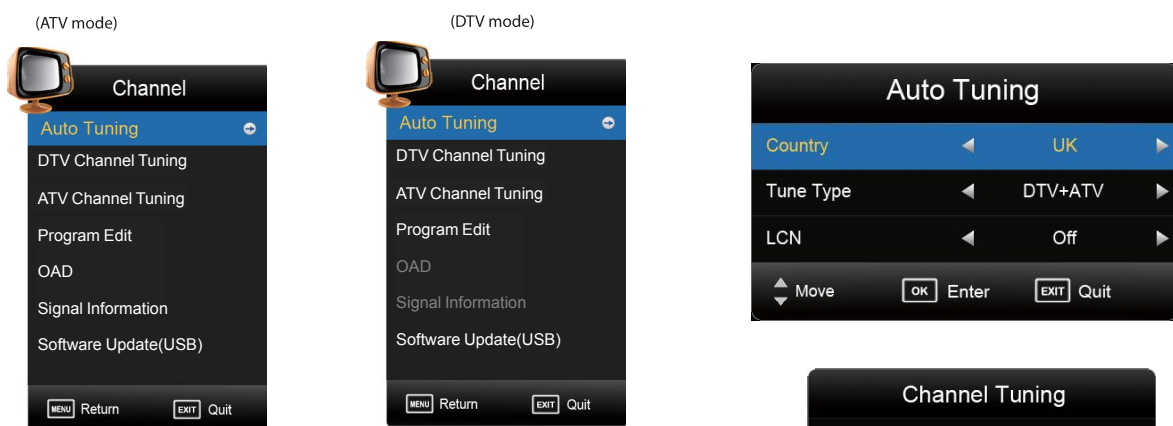

3. In the **Tune Type** menu, press the **◀▶** buttons to select **ATV / DTV / ATV +DTV**. Press the **▼** button and then press the **▲◀▶▼** buttons to select the country where you will operate the TV. Press the **OK** button to confirm.
4. Channel tuning will commence. This operation may take up to 10 minutes. The display will show the progress of the tuning and the number of channels found.
5. If you want to skip the DTV tuning, press the **Menu** button to interrupt the tuning half way. A pop-up screen will be displayed, press the **◀** button to select **YES** to confirm. You will then go straight to ATV tuning. You may repeat the above step if you also want to skip the ATV tuning. An installation reminder will appear the next time you turn on the TV.
6. After tuning is complete, the channels are stored and arranged in a preset order.



Channel Setting (TV, DTV or Radio Mode)

DTV Manual (CHANNEL) Tuning (DTV mode)

Allows you to make manual fine tuning adjustments of the channel under DTV mode.

1. Press the ▲▼ buttons to select **DTV CHANNEL Tuning** and then press the **OK** button.
2. The DTV Manual Tuning screen will pop up. Press the ◀▶ buttons to select the desired UHF channel and then press the **OK** button to commence the search of that channel. When the signal has been tuned, the picture and signal strength will be displayed on the screen.
3. Press the **Menu** button to return back to the main menu.
4. Press the **Exit** button to exit the menu.

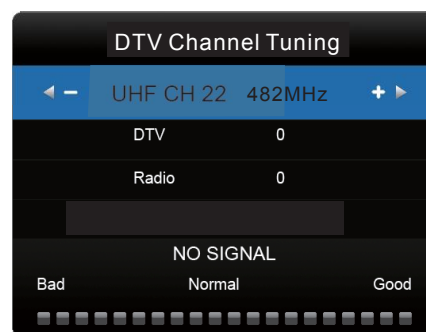

ATV Channel Tuning

To search analogue channel by entering parameters manually.

1. Press the ▲ buttons to **ATV Channel Tuning** then press the **OK** button to confirm.
2. Select **ATV manual search** item to enter air channel manual search in **ATV source** and the user operation interface as following.

Storage To	This item is disabled.
System	Select a TV system for searching.
Current Channel	Displays the current channel number.
Search	Press the ◀▶ buttons to start the manual tuning.
Fine-Tune	Press the ◀▶ buttons to make manual fine tuning adjustments.
Frequency	Select AFC On to lock the desired frequency.



3. Press the **Menu** button to return back to the main menu.
4. Press the **Exit** button to exit the menu.

Channel Setting (TV, DTV or Radio Mode)

Programme Edit (ATV Mode)

Allows you to edit TV programmes in the Channel List.

1. Press the **Menu** button to select the **CHANNEL** menu.
2. Press the **▲▼** buttons to select **Channel Edit** and then press the **OK** button.
3. A Channel Edit screen will pop up. Press the **▲▼** buttons to select the programme you want to edit.
 - a. **Delete**
Press the **RED** button to delete the selected channel.
 - b. **Move**
Press the **YELLOW** button and then press the **▲▼** buttons to move to the selected channel. Press the **YELLOW** button or the **OK** button to confirm.
 - c. **Skip**
Press the **BLUE** button to select the channels that you want to skip when you are selecting channels. Press the **BLUE** button again to undo it.
 - d. **Rename**
Press the **GREEN** button to rename the selected channel. Press the **▲▼** buttons to select the characters to represent the station name. Press the **◀▶** buttons to move to the next character and then press the **OK** button to confirm the new name.
4. Press the **Menu** button to return back to the main menu.
5. Press the **↩ Exit** button to exit the menu.

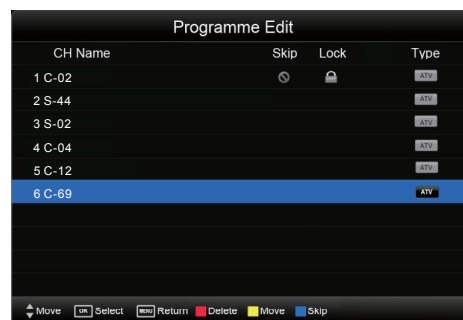

Programme Edit (DTV Mode)

Allows you to edit TV programmes in the Channel List.

1. Press the **Menu** button to select the **CHANNEL** menu.
2. Press the **▲▼** buttons to select **Programme Edit** and then press the **OK** button.
3. A Programme Edit screen will pop up. Press the **▲▼** buttons to select the programme you want to edit.
 - a. **Delete**
Press the **RED** button to delete the selected channel.
 - b. **Move**
Press the **YELLOW** button and then press the **▲▼** buttons to move to the selected channel. Press the **YELLOW** button or the **OK** button to confirm.
 - c. **Skip**
Press the **BLUE** button to select the channels that you want to skip when you are selecting channels. Press the **BLUE** button again to undo it.
 - d. **Rename**
Press the **GREEN** button to rename the selected channel. Press the **▲▼** buttons to select the characters to represent the station name. Press the **◀▶** buttons to move to the next character and then press the **OK** button to confirm the new name.
4. Press the **Menu** button to return back to the main menu.
5. Press the **↩ Exit** button to exit the menu.

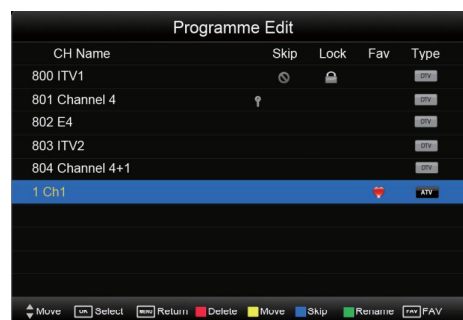

Channel Setting (TV, DTV or Radio Mode)

OAD

Allows you to choose the option

1. Press the **Menu** button to select the **CHANNEL** menu.
2. Press the **▲▼** buttons to select **OAD** and then press the **OK** button.

Software Update(OAD)

From time to time we may release new firmware to improve the running of the television (on air download)

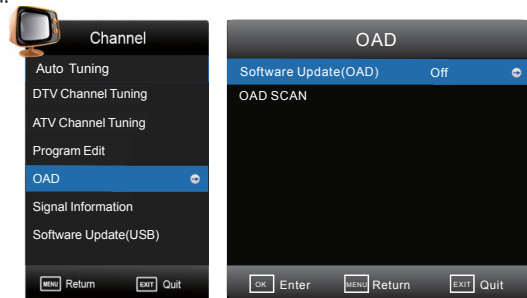

Signal Information

1. Press the **Menu** button to select the **CHANNEL** menu.
2. Press the **▲▼** buttons to select **Signal Information** sub menu option and then press the **OK** button to display "Signal Information"

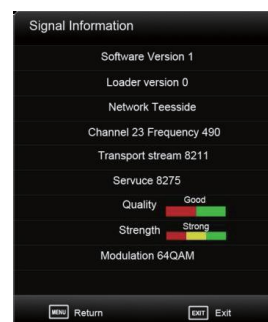

Picture Setting

Allows you to set your preferred picture mode.

1. Press the Menu button and then press the ▲▼ buttons to select the Picture menu.
2. Press the OK or ► buttons and then press the ▲▼ buttons to select the following picture options and then press the OK button.

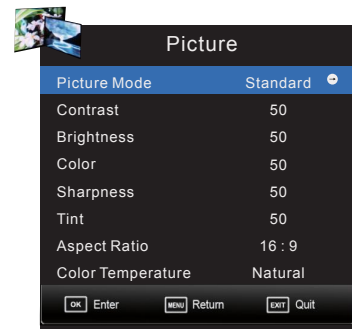

Picture Mode Press the ▲▼ buttons to cycle among picture mode: Dynamic / Ecohome Standard / Movie / User and then press the **OK** button to confirm.



Alternative

You may press the Picture button once and then press the ◀▶ buttons to select the picture mode directly.

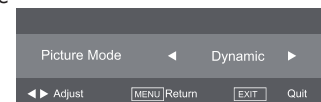

Contrast Press the ◀▶ buttons to adjust the difference between light and dark levels in the picture.(for User mode)

Brightness Press the ◀▶ buttons to increase or decreases the amount of white in the picture.(for User mode)

Colour Press the ◀▶ buttons to control the colour intensity.(for User mode)

Sharpness Press the ◀▶ buttons to adjust the level of crispness in the edges between light and dark areas of the picture.(for User mode)

Tint (For NTSC format) Press the ◀▶ buttons to adjust the balance between red and green levels. (Tint is only available for NTSC signal input via the SCART or AV IN.)









Aspect R atio Press the ▲▼ buttons to cycle among aspect ratio: Auto / 4:3 / 16:9 Full /Zoom1 /Zoom2 /Cinema/Just scan and then press the OK button to confirm.

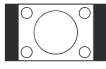
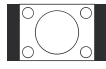

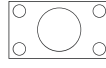
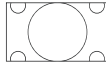
Alternative

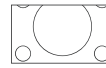
You may press the Picture button twice and then press the ◀▶ buttons to select the aspect ratio directly.

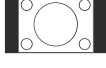
Picture Setting

	Input Signal 4:3	Input Signal 16:9
4:3	This selection will allow you to view a picture with an original 4:3 aspect ratio. Black bars will appear on both the left and right of the screen. 	This selection will allow you to adjust the picture horizontally, in linear proportion. Black bars will appear on both the left and right of the screen. 
16:9	This selection will allow you to adjust the picture horizontally, in linear proportion, to fill the entire screen. 	This selection will allow you to view a picture with an original 16:9 aspect ratio. 
Zoom1	This selection will allow you to zoom in the picture without any alteration, while filling the entire screen. However, the top and bottom of the picture will be cropped. 	This selection will allow you to zoom in the picture without any alteration, while the 4 sides of the picture will be cropped. 
Zoom2	This selection is similar to 16:9 mode, but the picture slightly stretches vertically and clips off a little from the top and bottom. 	This selection is similar to 16:9 mode, but the picture slightly stretches vertically and clips off a little from the top and bottom. 
Just scan (in HDMI mode only)	This selection will detect the resolution of the HDMI signal and display an image. with the same number of pixels 	This selection will detect the resolution of the HDMI signal and display an image. with the same number of pixels 

Colour Temperature

Press the ▲▼ buttons to cycle among colour temperature: Standard / Cool / Warm and then press the **OK** button to confirm. Adjusts the colour components independently to achieve a warm or cool.

- Standard
- **Cool:** Increases blue tint
- **Warm:** Increases red tint

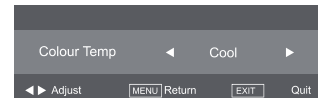

Noise Reduction Press the ▲▼ buttons to select to reduce the noise level of the connected device: Off / Low / Middle / High / Auto and then press the **OK** button to confirm.

3. Press the **Menu** button to return to the previous menu. Press the **Exit** button to exit the menu.

Sound Setting

Allows you to adjust your TV audio settings.

1. Press the **Menu** button and then press the ◀▶ buttons to select the **Sound** menu.

2. Press the ▲▼ buttons to select the following sound options and then press the **OK** button.

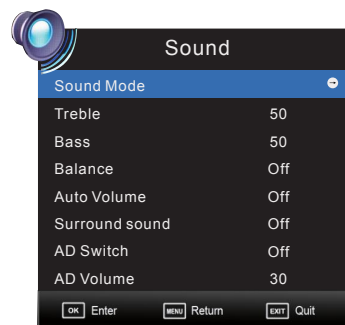

Sound Mode	Press the ▲▼ buttons to select an audio-enhancement technique: Standard / Music / Movie / Sports / User and then press the OK button to confirm.
Treble	Press the ◀▶ buttons to control the relative intensity of higher pitched sounds. (for user mode)
Bass	Press the ◀▶ buttons to control the relative intensity of lower-pitched sounds. (for user mode)
Balance	Press the ◀▶ buttons to adjust the relative volume of the speakers in a multiple speaker system.
Auto Volume	Press the ◀▶ buttons to turn on / off the auto volume. Select On to automatically control the volume. (e.g. advertisements tend to be louder than the programmes)
Surround Sound	Turn on/off the surround sound function by selecting "On" or "Off".
AD Switch (For DTV mode)	Audio Description is an auxiliary audio function that provides an additional audio track for visually challenged persons. This function handles the Audio Stream for the AD (Audio Description), when it is sent along with the main audio from the broadcaster. <ul style="list-style-type: none"> Set to "Off" for normal broadcasting sound coming out from speakers. Set to "On" to activate the description sound track if available. The availability of Audio Description sound track is indicated by the visually impaired icon "V.I." in the information banner.
AD Volume	When the AD Switch Set to " Off ", this function disavailable. When the AD Switch Set to " On ", you can press ◀▶ buttons to adjust the AD Volume .
SPDIF Mode	SPDIF is used to provide digital sound. Press [OK] button to set Off, PCM or Auto.

3. Press the **Menu** button to return to the previous menu. Press the **Exit** button to exit the menu.

Application Setting

1. Press the **Menu** button and then press the ◀▶ buttons to select the **Application** menu.
2. The application menu displays all available smart options.



3. Press the **Menu** button to return to the previous menu. Press the **Exit** button to exit the menu.

Connecting a USB Storage Device

1. Switch off the TV before connecting any USB storage device.
2. Connect your USB storage device to the USB port of your TV.
3. Plug the connected devices into the mains socket
4. Press the **STANDBY** button on of the TV or the **⏻** button on the remote control to turn on your TV.
5. Press the **SOURCE** button on the TV or the **SOURCE** button on the remote control to display the Source List. Use the **▲▼** buttons to select **Media** and then press the **OK** button to confirm.

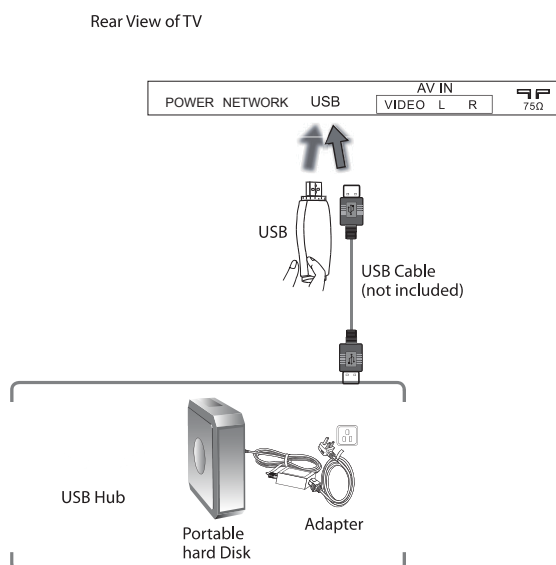

- If a hard disk is used, make sure its mains adapter is connected to the mains supply.
- If a USB hub is used, make sure its mains adapter is connected to the mains supply as the total current consumption may exceed 500mA.
- The maximum supported storage space of the hard disk is 1 TB.
- The file system only supports HiSpeed FS, FAT16, FAT32, NTFS formats (NTFS Compressed files are not supported).
- If you want to store the video streaming of a DTV programme, the transfer rate of the USB storage device must not be less than 5MB/s, otherwise the picture and sound of the programme will be affected and a warning statement will be shown on the screen. If this happens, please upgrade your USB storage device.
- The TV screen will be blank temporarily as it will take time to start up and stabilise the connected hard disk. This is normal and the starting time may vary depending on the brand and the memory size of the connected hard disk.
- Disconnect the USB storage device if it is not in use.
- USB output: DC 5V  500mA

Multimedia Operation

Basic Operation

- 1). Press the **menu** button on the remote control to display the input source menu, select the **Media Player** with the **◀▶** buttons and press the **OK** button to enter the Multimedia menu below.
- 2). Insert the USB device, the name of the device will be displayed on the screen.
- 3). Press **◀/▶** button to select the files on the USB device (PHOTO, MUSIC, MOVIE) to view or play.

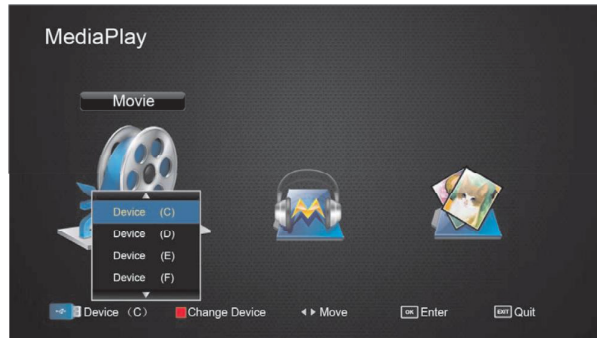

Press **◀/▶/▲/▼** buttons to select and the **OK** button to activate the file or open folder. Press **▶** button to play the files in full screen mode. When in full screen mode press the **OK** button to show the navigation option menu on the bottom of the screen or press **■** stop button to return to files.

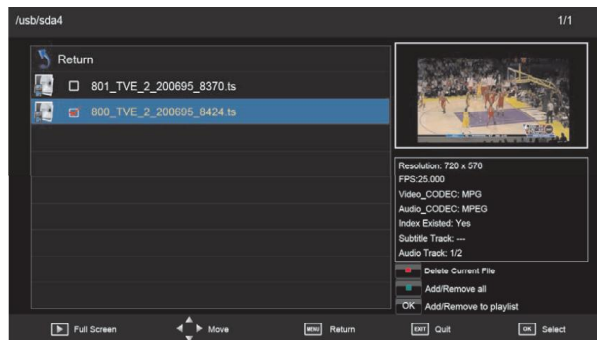

Multimedia Operation

1. Movie

If you select Movie, press [OK] button to focus the USB icon, then press [OK] again to the FileSelector menu.

Press▲/▼ button to select file, press [OK] button to mark "✓" and add it into playlist.
If the file is highlighted blue 1-2 seconds, the file will play in the preview

Press [PLAY] button to play the selected files in the full screen.

Press [EXIT] button to quit.

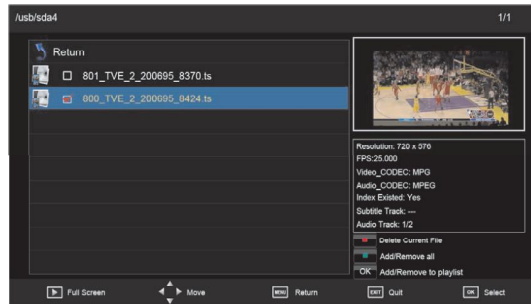

2. Music

Listen to music



Back to the Media Player menu and select Music, press [OK] button to focus the USB icon, then press [OK] again to the File Selector menu.

Press [PLAY] button to play the selected files in the full screen.

Press [EXIT] button to quit.

Multimedia Operation

3. Photo

Photo viewing

Back to the Media Player menu and select Photo, press [OK] button to focus the USB icon, then press [OK] again to the File Selector menu.

Press [PLAY] button to play the selected files in the full screen.

Press [EXIT] button to quit.



Setting Menu

Allows you to set up a variety of feature options.

1. Press the Menu button and then press the ▲▼ buttons to select the **Setting** menu.
2. Press the OK or buttons and then press the ▲▼ buttons to select the following feature options and then press the OK button.
3. Press the **Menu** button to return to the previous menu. Press the **Exit** button to exit the menu.

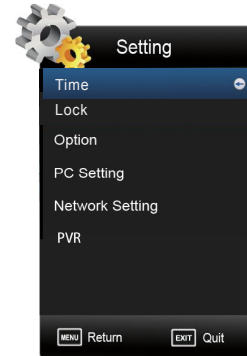

Time

Allows you to adjust sleep timer.

1. Press the **Menu** button and then press the ◀▶ buttons to select the **SETTING** menu.
2. Press the ▲▼ buttons to select the following time options and then press the **OK** button.

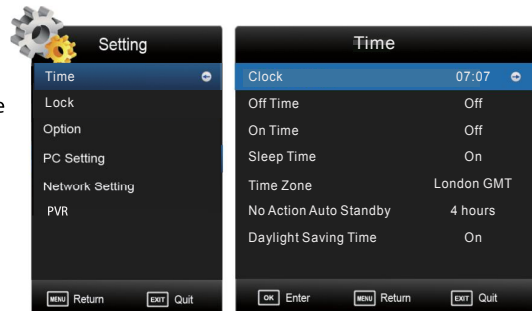

Clock The clock time is set automatically by the DTV TV Broadcasting signal

Off Time Auto power off setting. Press [OK] button to display Off Time. Press ◀/▶ to select the mode. (Available mode: Off~Once~Everyday-Mon~Fri-~Mon~Sat-~Sat~Sun~Sunday). Then set the hour and minute according to the prompt.

On Time Auto power on setting. Press [OK] button to display On Time. Press ◀/▶ to select the mode. (Available mode: Off~Once~Everyday-Mon~Fri-~Mon~Sat-~Sat~Sun~Sunday). Then set the hour, minute, source, channel, and volume according to the prompt.

Sleep Timer The sleep timer automatically switches the TV to standby after the preset time has elapsed. The clock will be set automatically when receiving a digital signal. Time must be set before using Sleep Timer function.

Time Zone When you select a Time Zone city, the TV time is set by the time offset information based on Time Zone and GMT (Greenwich Mean Time) which is received with the broadcast signal and the time is set automatically by a digital signal.

No Action Auto Standby The unit will automatically switch to standby mode 4 hours after the last time the remote control was used. A reminder screen will pop up and count down before the unit switches to standby mode. If you want to operate the TV for a long period of time, turn off the auto standby function.

Daylight Saving Time (On ,Off) if it's On, it'll be an hour earlier than the GMT. If Time Zone is set to Auto, it's not available.

Setting Menu

Lock

To access the **LOCK** menu, you must enter the password. Enter the default password "0000" for first time use. To change the password, please refer to "Set Password".

The Lock System is designed to prevent accidental retuning of the TV / losing channels and prevent children watching unsuitable programmes.

The Lock System must be set to On for this function to operate. If the Lock System is set to On, a valid password must be entered when you access Auto Tuning / Manual Tuning / Restore Factory Default.

1. Press the **Menu** button then press the ◀▶ buttons to select the **SETTING** menu.
2. Press the ▲▼ buttons to select **Lock System** and then press the **OK** button.
3. Use the **0-9** buttons to input a 4-digit password to enter the **LOCK** menu.
 - The default password is "0000".
 - If you change the password, be sure to remember the new password! If you forget the new password, press the master password "8899".
4. Press the ▲▼ buttons to select **Lock System** and then the **OK** buttons to select **On / Off**.
If the Lock System is set to On, a valid password must be entered when you access Auto Tuning / Manual Tuning / Channel Edit / First Time Installation / Restore Factory Default.
5. Press the **Menu** button to return to the previous menu. Press the ↵ **Exit** button to exit the menu.

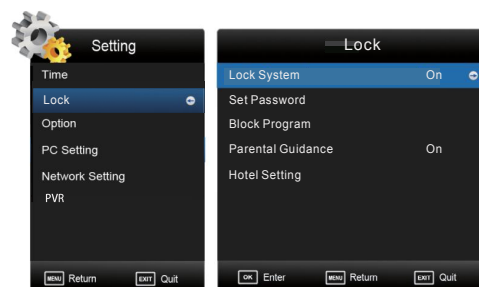

Set Password

1. Press the **Menu** button and then press the ▲▼ buttons to select the **SETTING** menu and then press the **OK** button.
2. Press the ▲▼ buttons to select **Set Password** and then press the **OK** button.
3. Use the **0-9** buttons to input the old password and then input the new 4-digit password. Re-enter new password for confirmation.
 - The default password is "0000".
 - If you change the password, be sure to remember the new password! If you forget the new password, press the master password "8899".
4. Press the **Menu** button to return to the previous menu. Press the ↵ **Exit** button to exit the menu.

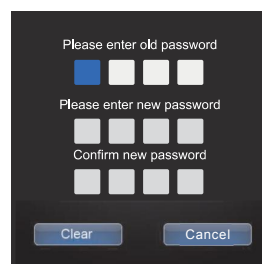

Setting Menu

BBlock Program is designed to prevent children watching unsuitable programmes.

1. Press the **Menu** button then press the ◀▶ buttons to select the **SETTING** menu.
2. Press the ▲▼ buttons to select **Lock** and then press the **OK**
3. press the **OK** and Use the **0-9** buttons to input a 4-digit password to enter the **LOCK** menu and then press the **OK** button to turn the Lock System **On**.



- The default password is "0000".
- If you change the password, be sure to remember the new password! If you forget the new password, press the master password "8899".

4. Press the ▲▼ buttons to select **BBlock Program** and then press the **OK** button.
5. A **Block Channel** screen will pop up. Press the ▲▼ buttons to select a channel. Press the **GREEN** button on the remote control to lock or unlock the channel. Press the **GREEN** button again to unblock.
6. Press the **Menu** button to return to the previous menu. Press the ↵ **Exit** button to exit the menu.



When a channel is blocked, a valid password must be entered.

Parental Guidance

This function allows you to set up blocking schemes to block specific programmes and ratings. It operates according to information from the broadcasting station, therefore if the signal has incorrect information, this function will not operate.

This TV is programmed to remember which option it was last set to even if you switch the TV off.

1. Press the **Menu** button then press the ◀▶ buttons to select the **SETTING** menu.
2. Press the ▲▼ buttons to select **Parental Guidance** and then press the **OK** button.
3. Use the **0-9** buttons to input a 4-digit password to enter the **LOCK** menu and then press the **OK** button to turn the Lock System **On**.



- The default password is "0000".
- If you change the password, be sure to remember the new password! If you forget the new password, press the master password "8899".

4. Press the ▲▼ buttons to select **Parental Guidance** and then press the **OK** button.
5. Press the ▲▼ buttons to select an age rating: Off, 4-18. Then press the **OK** button to confirm to return to the previous menu.
6. Press the **Menu** button to return to the previous menu. Press the ↵ **Exit** button to exit the menu.



When a programme is rated above the selected age rating, the programme will be blocked, a valid password must be entered.

Hotel Setting

Hotel Mode is for users that require limited access to services and levels.

Setting Menu

Option

Allows you to choose the option.

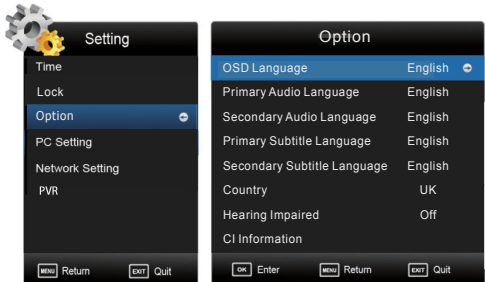
OSD Language	Default is set to English. To change the language use the ▲/▼ buttons.	
Audio Language	If the programme providers transmit another language this may be selected. The default is set to English.	
Subtitle Language	If the programme providers transmit another language this may be selected.	
Country	display the selected country	

Hearing Impaired Turn ON/OFF the Hearing Impaired function

CI Information Press [OK] button, it will show "No CI Module" if no CI card is inserted.

After you have inserted the CI card, it will show "CI Module Inserted", then display the CI information.

CI Information

Irdeeto Access
IRDETO-MAIN

- Module Information
- Smart card Information
- Language
- Software Download

Press OK to select, or Exit to quit



CI Module Inserted

Exit

HDMI CEC "HDMI CEC" function setting

- H D M I C E C " HDMI CEC" function switch
- A u t o T u r n O f f "Auto Turn Off" function switch
- D e v i c e L i s t Press to display "Device List"



Restore to Default If you are unsure if your modified settings are correct and you want to revert back to Factory settings then activate the Restore to default option.
(Restore Settings) This will not effect your currently tuned channels or set passwords.

PC Setting (Only used in the PC source)

Press Menu and use ▲▼◀▶ button to PC Setting. You can adjust the Horizontal Pos, Vertical Pos, Size, Phase of the picture, or auto adjust by selecting "Auto Adjust"

Setting

- Time
- Lock
- Option
- PC Setting
- Network Settings
- PVR
- 3D

MENU Return EXIT Quit

VGA

- Auto Adjust
- H Position 50
- V Position 50
- Size 50
- Phase 50

OK Enter MENU Return EXIT Quit

Setting Menu

Network Setting

1. Press the Menu button and then press the ◀▶ button to select the Network Setting menu.
2. Press the ▶ buttons to select from the following options and then press the OK button

1 Wired



Press [OK] key to enter the settings of the wired network:

Internet Protocol Setup: Manually set the IP of the wired network information, or to automatically obtain the IP information of the wired network

IP/Netmask/Gateway/DNS: Manual state is selected; the Auto state is not optional

MAC Address: Displays the MAC address of the motherboard. Not selectable

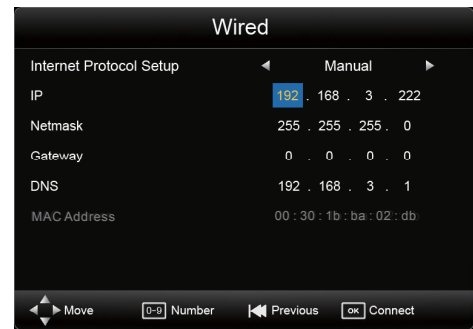

After setting, press [OK] button to connect, the connection is successful you receive the following message:

If the setting is not completed or the connection fails, "Wired network setting not complete. Internet connected Fail!" Prompt appears.



2 Wi-Fi

The Wireless connection status is displayed on the screen as below.



Setting Menu

Press [OK] key to enter the wireless network settings:

- (Green button) Refresh network list.
- (Yellow button) Show detailed information of the selected network.

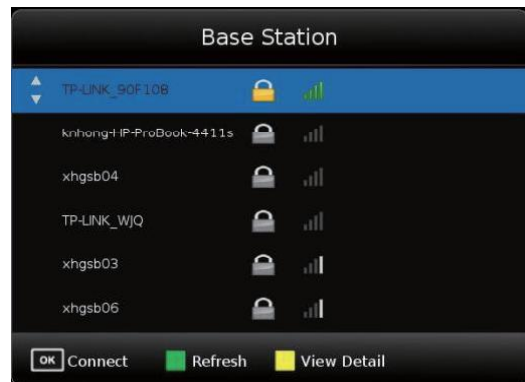

a) if it is on a secure wireless network, the press [OK] key will appear the following menu:

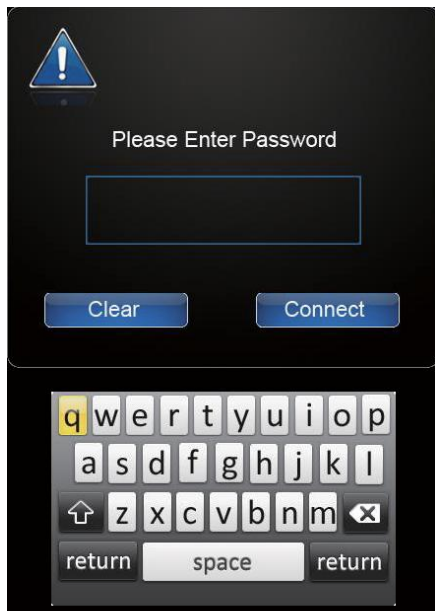

b) if it is on a non-encrypted wireless network, the press [OK] key will appear the following menu:



b) after entering the password and not encrypted connection procedure is complete there will be two prompt menu: Left success, failure right:



Setting Menu

PVR (DTV Mode)

Allows you to select your preferences in the PVR .

1. Press the **Menu** button then press the ◀▶ buttons to select the **EXTRAS** menu.
2. Press the ▲▼ buttons to select **PVR** and then press the **OK** button.



Recorder List Press OK button to enter the recorder list menu:
Press RED button to delete any programme.
Press Info button to display programme information.

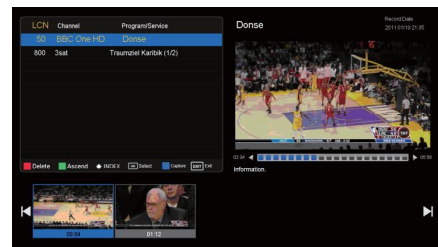

Recorder The TV will record the programme automatically according to your settings.
Press OK button to enter the timer record.

- Start time:** Select the record time begin
- End time:** Select the record time end
- Press the OK button to save and exit the menu



Schedule List		02:24 18 05			
Mode	Time	Date	Programme Title	Channel Name	
Once	02:32-02:35	Fri, 18 Apr 2008	Papa baston	NT1	▶

Navigation: ◀ Move, Delete, Return, EXIT Quit

Schedule List Press to display Schedule List.
Note: Delete any scheduled recordings with the RED button.

Setting Menu

PVR File System (DTV Mode)

Allows you to select your preferences in the PVR File System.

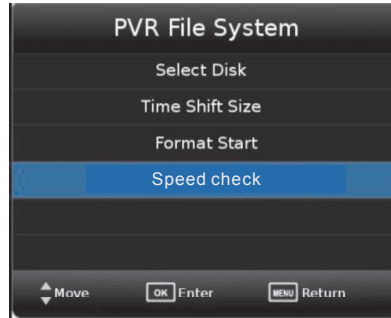

Select Disk :

Select the disk which you want to record to, when there are more than two recording devices



Time Shift Size :

Select the amount of memory you wish to allocate to the Time shift (record live TV function)

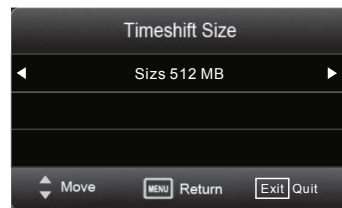

Format Start :

Press [OK] button to format device



Speed Check :

Press [OK] button to check device speed. It will show the value a few minutes later.

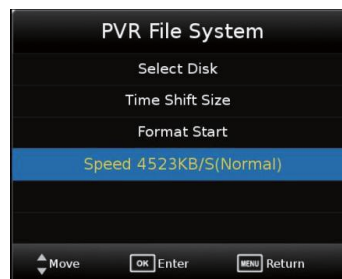

EPG (Electronic Programme Guide) (DTV Mode)

This system has an Electronic Programme Guide (EPG) to help you navigate through all the possible viewing options.

The EPG supplies information such as programme listings, start and end times for all available services. In addition, detailed information about the programme is often available in the EPG (the availability and amount of programme information will vary, depending on the particular broadcaster).

This function can be used only when the EPG information is broadcast by broadcasting companies.

The EPG displays the programme details for the next 7 days.

Switch On / Off EPG

1. Press the **EPG** button to switch on EPG.
2. Press the **EPG** button or the **Exit** button again to switch off EPG and return to normal TV viewing.

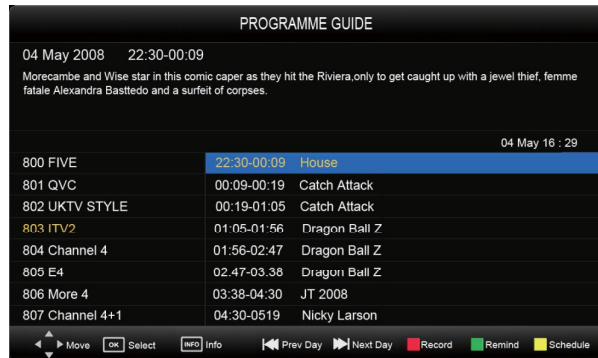

Select a Programme

Press the **▲▼** buttons to select the desired channel. Press the **OK** button to confirm.

Button Functions in a 7 Days Guide

Remote Control Button	Function
RED (Record)	<ul style="list-style-type: none"> • Timer Programming See page 50 for details on Timer Programming. • Press the RED button in the Schedule List to delete the selected preset reminder.
GREEN (Remind)	Press the GREEN button to display the remind menu, and set the time. When the programme starts the TV will automatically switch to this programme.
YELLOW (Schedule)	Press the YELLOW button to view the preset reminders or scheduled recordings in the Schedule List .



Teletext (ATV Mode)

Teletext is a free service broadcast by some TV stations which gives up-to-the-minute information on news, weather, television programmes, share prices and many other topics. Using the Teletext control buttons you can view pages of information that are listed in the teletext index.

To Turn on Teletext Function



Make sure the TV channel you are watching transmits teletext.
"No Teletext" sign will show on the screen if teletext is not available.

In ATV mode, press the **T ext** button to enter Teletext mode.

Press the **T ext** button three times to exit and the TV will return to the channel you were watching.

To select a page of text

Find the number of the page in the index and enter it using the **0-9** buttons. The number of the page will appear on the top left corner of the screen.

The page counter will search for your page. When it finds it, the page will be displayed.

To move to the next page of text, press the **▲** button.

To move to the previous page, press the **▼** button.

Mix

To view a page of text while watching a TV programme, press the **T ext** button twice. The text will be superimposed over the TV programme.

Fasttext

At the bottom of the teletext screen is a row of subject headings in red, green, yellow and blue.

The remote control has a row of colour buttons corresponding to the row of coloured subjects on the screen.

Pressing one of the colour buttons will take you directly to the page corresponding to the subject heading.

Digital Teletext (DTV Mode)

Digital teletext can access special digital teletext services and specific services which broadcast digital teletext. You will need to turn off **Subtitle Function** before using teletext.

Teletext within Digital Service

1. Press the **TEXT** button to display the teletext page. If no Teletext service is available, a "No Teletext" message will be displayed.
2. Press the **0-9** buttons to select a page number.
3. Follow the instructions on digital teletext and move onto the next step by pressing **OK**, **▲◀▶▼**, **RED**, **GREEN**, **YELLOW**, **BLUE** or **0-9** buttons etc.
4. To change digital teletext service, select a different service by pressing the **0-9** buttons or the **▲▼** buttons.



Alternative

You may press the **RED** button or the **T ext** button to display the teletext information when you see a **●** red logo displayed on the screen (e.g. BBC).

5. Press the **TEXT** button to exit.

Maintenance

Careful and regular cleaning can prolong the life of your TV.



Be sure to Disconnect the mains cable from the mains socket before any cleaning.

1. Use a soft dry cloth to wipe away the dust from the screen and surfaces.
2. If the surfaces are extremely dirty, clean the TV with a cloth which has been dipped in a weak soapy water. Wring the cloth until it is almost dry, then use it to wipe the TV.
3. Ensure there is no excess water on the screen. Allow any water or dampness to evaporate before switching the TV on.

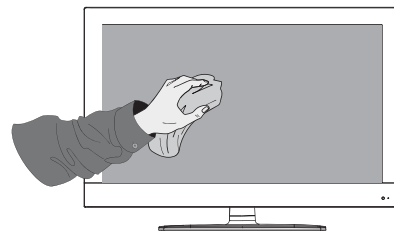

Never use alcohol, benzene, paint-thinner, cleaning fluid or other chemicals. Do not use compressed air to remove dust.

Hints and Tips

The TV does not operate properly.

The TV does not respond when pressing any buttons	<ul style="list-style-type: none">• The TV may freeze up during use. Disconnect the mains cable from the mains socket for a few minutes. Reconnect the mains cable and try to operate it again as usual.
TV cannot be switched on	<ul style="list-style-type: none">• Check that the TV is connected to the mains supply• Make sure all connected AV devices are switched off before switching on your TV.
The remote control does not work	<ul style="list-style-type: none">• Check to see if there are any objects between the TV and the remote control causing an obstruction. Ensure that you are pointing the remote control directly at the TV.• Ensure that the batteries are installed with the correct polarity (+ to +, - to -).• Install new batteries.
Power is suddenly turned off	<ul style="list-style-type: none">• Check the power of the TV. The mains supply maybe interrupted.• Check if the sleep timer is set.• Check whether the Auto Standby is activated.

The video function does not work.

No Picture & No Sound	<ul style="list-style-type: none">• Check whether the TV is switched on.• Try another channel. The problem may be caused by the broadcaster.
Picture appears slowly after switching on	<ul style="list-style-type: none">• This is normal, the image is muted during the TV startup process. Please contact your service centre, if the picture has not appeared after five minutes.
No or poor colour or poor picture	<ul style="list-style-type: none">• Adjust the settings in the PICTURE menu.• Try another channel. The problem may be caused by the broadcaster.• Check if the video cables are connected properly.
Horizontal / Vertical bar or picture shaking	<ul style="list-style-type: none">• Check for local interference such as an electrical appliance or power tool.
Poor reception on some channels	<ul style="list-style-type: none">• Station or cable channel may be experiencing problems, tune to another station.• Station signal is weak, reposition the aerial for better reception.• Check for sources of possible interference.
Lines or streaks in pictures	<ul style="list-style-type: none">• Check aerial (Change the position of the aerial.)
No pictures when connecting HDMI	<ul style="list-style-type: none">• Check if the input source is HDMI.
Picture appears in wrong ratio	<ul style="list-style-type: none">• Adjust the Aspect Ratio settings in the PICTURE menu.

Hints and Tips

The audio function does not work.

Picture OK but no sound	<ul style="list-style-type: none">• Press the VOL + / - buttons.• Sound muted? Press the Mute button.• Try another channel. The problem may be caused by the broadcaster.
No output from one of the speakers	<ul style="list-style-type: none">• Adjust the Balance settings in the SOUND menu.
Unusual sound from Inside the TV	<ul style="list-style-type: none">• A change in ambient humidity or temperature may result in an unusual noise when the TV is switched on or off and does not indicate a fault with the TV.
No sound when connecting HDMI	<ul style="list-style-type: none">• Check if the input source is HDMI.
Audio noise	<ul style="list-style-type: none">• Keep the RF coaxial cable away from the other connected cables.

Password

Lost Password	<ul style="list-style-type: none">• Select the Change Pin Code setting in the FEATURE menu, then enter the following master password "8899". The master password clears your previous password and allows you to enter a new password.
---------------	--

There is a problem in PC mode.

The signal is out of range (Invalid format)	<ul style="list-style-type: none">• Adjust the resolution, horizontal frequency, or vertical frequency.
Vertical bar or stripe on background & Horizontal Noise & Incorrect position	<ul style="list-style-type: none">• Use Auto configure or adjust clock, phase, or H/V position.
Screen colour is unstable or single colour	<ul style="list-style-type: none">• Check the signal cable.• Reinstall the PC video card.

FAQs (Frequently Asked Questions)

Why have I lost some / all of my channels?	<ul style="list-style-type: none">• It happens sometimes, if you have a weak signal. Usually it just means you'll need to rescan your digital box or TV. Don't worry, it's easy to do. And once you've done it, you should get all the Freeview channels available to you. If problems persist you may need to get your aerial checked. Talk to your retailer or contact your local aerial installer.
Why do I get 'blocking' on my digital picture?	<ul style="list-style-type: none">• In most cases, blocking is caused by a reception problem – either the signal is too weak or there is some kind of interference. Talk to your retailer or contact your local aerial installer.• Blocking can also be caused by a digital signal that is too strong. If you are still experiencing blocking and the signal is strong, consult your local aerial installer for advice.
Can I watch Freeview using a portable set-top aerial?	<ul style="list-style-type: none">• Some, but only a few, homes may be able to use a set top aerial. However, for a much better reception, we strongly recommend that you use a rooftop aerial.• If you do not have access to a rooftop aerial – for example, if you rent a flat and the aerial is the responsibility of your landlord, or if you're using a second TV in the bedroom and don't want the hassle and expense of using extension cables, a set – top aerial may be your only option.
What type of aerial do I need?	<ul style="list-style-type: none">• If you are installing a new aerial, we recommend a wideband rooftop aerial rather than a loft aerial. Loft aerials generally receive a weaker digital signal and are more likely to get interference from other electrical devices in the home. We suggest you have an aerial survey done before getting an aerial upgrade.• Talk to your retailer or contact your local aerial installer.

Display Modes

The screen resolution has been optimised during production for the display modes listed below.

YPbPr Mode

Resolution	Vertical Frequency (Hz)	Aspect Ratio
480i: 720 x 480	60	4:3 / 16:9 / Zoom1 / Zoom2
480P: 720 x 480		
576i: 720 x 576	50	
576P: 720 x 576		
720P: 1280 x 720	50	
	60	
1080i: 1920 x 1080	50	
	60	
1080P: 1920 x 1080	50	
	60	

HDMI Mode

Resolution	Vertical Frequency (Hz)	Aspect Ratio
480i: 720 x 480	60	4:3 / 16:9 / Zoom1 / Zoom2 / Just Scan
480P: 720 x 480		
576i: 720 x 576	50	
576P: 720 x 576		
720P: 1280 x 720	50	
	60	
1080i: 1920 x 1080	50	
	60	
1080P: 1920 x 1080	50	
	60	

TV Specifications

Panel System	65 inch LED Panel
Display Resolution	3840 pixels (horizontal) x 2160 pixels (vertical)
Television System	PAL I / BG / DK / SECAM BG / DK
Brightness	250 cd/m ²
Contrast Ratio	5000 : 1
Power Source	AC 100V~240A
Energy Efficiency Class	A
Screen Size (measured diagonally)	Approx.165 cm (65 inch)
Operating Power Consumption	156W
Average Annual Energy Consumption	228 kWh
Standby Power Consumption	< 0.5 W
Operating Temperature	0°C – 40°C
Vesa Wall mounting size / Screw size	400 x 400mm / M6 x 25
Speaker Power	5W+5W
Dimension (W x D x H)without base	1462 x 74 x 848mm
Dimension (W x D x H) with base	1462 x 290 x 907mm

Features and specifications are subject to change without prior notice.

This TV has been tested against the European standards for Energy efficiency using the standard signals and conditions specified in the standard. The result is shown on the energy efficiency label. This is the energy that you would expect the TV to consume under normal working conditions when measured over a period of time. At some times the TV will use more power than this and at some times less. The factors that cause this fluctuation are the actual signals being received, and the Volume setting. Generally speaking the mains voltage, brightness / contrast settings and other settings have a very small effect on energy usage and can to all intents and purposes be ignored. The difference between the power consumed when receiving a high bit rate channel with the volume at max and a low bit rate channel with volume at zero is usually less than 3 watts.

Safety Warnings

- Read **all** the instructions carefully before using the unit and keep them for future reference.
- Retain the manual. If you pass the unit onto a third party make sure to include this manual.
- Check that the voltage marked on the rating label matches your mains voltage.

Damage

- Please inspect the unit for damage after unpacking.
- Do not continue to operate the unit if you are in any doubt about it working normally, or if it is damaged in any way - switch off, withdraw the mains plug and consult your dealer.

Location of Unit

- The unit must be placed on a flat stable surface and should not be subjected to vibrations.
- Do not place the unit on sloped or unstable surfaces as the unit may fall off or tip over.
- The mains socket must be located near the unit and should be easily accessible.
- This unit is designed for indoor use only.

Temperature

- Avoid extreme degrees of temperature, either hot or cold. Place the unit well away from heat sources such as radiators or gas / electric fires.
- Avoid exposure to direct sunlight and other sources of heat.

Naked Flames

- Never place any type of candle or naked flame on the top of or near the unit.

Moisture

- To reduce the risk of fire, electric shock or product damage, do not expose this unit to rain, moisture, dripping or splashing. No objects filled with liquids, such as vases, should be placed on the unit.
- If you spill any liquid into the unit, it can cause serious damage. Switch it off at the mains immediately. Withdraw the mains plug and consult your dealer.

Ventilation

- To prevent the risk of electric shock or fire hazard due to overheating, ensure that curtains and other materials do not obstruct the ventilation vents.
- Do not install or place this unit in a bookcase, built-in cabinet or in another confined space. Ensure the unit is well ventilated.
- Make sure that there is a gap of at least 10 cm on both sides and a gap of 20 cm at the top.

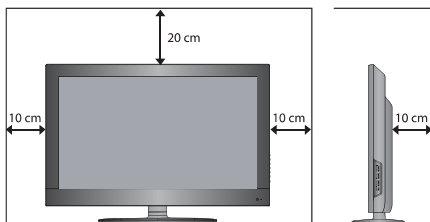

Safety

- Always disconnect the unit from the mains supply before connecting / disconnecting other devices or moving the unit.
- Unplug the unit from the mains socket during a lightning storm.

Mains Cable

- Make sure the unit or unit stand is not resting on top of the mains cable, as the weight of the unit may damage the mains cable and create a safety hazard.
- If the mains cable is damaged it must be replaced by the manufacturer, its service agent, or similarly qualified persons in order to avoid a hazard.

Interference

- Do not place the unit on or near appliances which may cause electromagnetic interference. If you do, it may adversely affect the operating performance of the unit, and cause a distorted picture or sound.

Optimum viewing

- View the unit in moderate light to prevent eye strain. It is recommended to watch the unit from a distance 3-7 times that of the screen height.

LED screen

- The LED screen is manufactured using high-precision technology. However, some tiny black points and / or bright points (red, blue or green in colour) may constantly appear on the LED screen. These points are generated in the manufacturing process and are normal.

Screen Burn

- A characteristic of Plasma and LED TV Panels is that displaying the same image for a long time may cause a permanent after-image to remain on the screen. This is called screen burn. Most pictures shown on the unit will be constantly moving and fill the screen.
- Examples of images that you need to watch out for are as follows (this is not an all-inclusive list):
 1. **Black Bars:** If black bars appear at the left / right or top / bottom of the screen, it is recommended to change the format so that the picture fills the entire screen.
 2. **TV Channel Logos:** e.g. Shopping channel logos and pricing displays - especially if they are bright and stationary. Moving or low-contrast graphics are less likely to cause ageing of the screen.
 3. **Time Displays**
 4. **Teletext:** Do not view a stationary page for long periods of time.
 5. **TV Menus**
 6. **Pause Mode:** Do not leave the screen in pause mode for long periods of time, e.g. when watching videos.
- To prevent screen burn if viewing any of the above for long periods of time, reduce contrast and brightness when viewing. Once burn-in occurs it will never disappear completely.

Headphones

- Listening to loud sounds for prolonged periods of time may permanently damage your hearing.
- Before putting on headphones, turn the volume down then put the headphones on and slowly increase the volume until you reach a comfortable listening level.

Standby

- The  button on the remote control does not switch off the unit completely. The unit will continue to draw electricity from the mains supply while in standby. In the interests of safety and to avoid unnecessary energy consumption, never leave the unit in standby while unattended for long periods of time, e.g. overnight, while on holiday or while out of the house. Switch it off and disconnect the mains plug from the mains socket.

Batteries

- Batteries used in the remote control for this unit are easily swallowed by young children and this is dangerous.
- Keep loose batteries away from young children and make sure that the battery holder tray is secure in the remote control. Seek medical advice if you believe a cell has been swallowed.
- Please dispose of batteries correctly by following the guidance in this manual.

Supervision

- Children should be supervised to ensure that they do not play with the unit and the remote control.
- Never let anyone especially children push anything into the holes, slots or any other openings in the case - this could result in a fatal electric shock.



The lightning flash with arrowhead symbol, within an equilateral triangle, is intended to alert the user to the presence of uninsulated “dangerous voltage” within the unit’s enclosure that may be of sufficient magnitude to constitute a risk of electric shock.



The exclamation point within an equilateral triangle is intended to alert the user to the presence of important operating and maintenance (servicing) instructions in the manual accompanying the unit.



Service

- To reduce the risk of electric shock, do not remove screws. The unit does not contain any user-serviceable parts. Please leave all maintenance work to qualified personnel.
- Do not open any fixed covers as this may expose dangerous voltages.

Maintenance

- Ensure to unplug the unit from the mains socket before cleaning.
- Do not use any type of abrasive pad or abrasive cleaning solutions as these may damage the unit’s surface.
- Do not use liquids to clean the unit.

Important Note

This TV is fitted with the latest ECO friendly power saving technology. If whilst viewing the TV remote control is not used for a period of 4 hours, the Auto Standby feature will operate and power down the TV. A warning message will be displayed to inform you that the TV is about to power down.

This option can be disabled by setting the Auto standby to OFF in the Settings/ Time menu.



Packaging materials are not toys. Please keep away from children. Plastic bags can cause suffocation when pulled over the head.

Waste Electrical Recycling

Correct disposal of Product



This sign indicates that this product may not be disposed of with your regular household waste. The recycling and separate collection of such products is your responsibility. Please drop off the above mentioned waste at a designated place for recycling waste electrical and electronic equipment. If you do not know where to drop off your waste equipment for recycling, please contact your local city office or household waste collection service.



The crossed out wheeled dust bin symbol indicates that batteries and /or accumulators must be collected and disposed of separately from household waste.

If the battery or accumulator contains more than the specified values of lead (Pb), mercury (Hg), and/or cadmium (Cd) defined in the Battery Directive (2006/66/EC), then the chemicals symbols for lead(Pb), mercury (Hg) and/or cadmium (Cd) will appear below the crossed out wheeled dust bin symbol.



By participating in separate collection of batteries, you will help to assure the proper disposal of products and batteries thus help to prevent potential negative consequences for the environment and human health.

For more detailed information about the collection and recycling programmes available in your country, please contact your local city office or the shop where you purchased this product.



This appliance complies with European Safety and Electrical directives.

It fulfills the following EU regulations:

EN 55022:2006+A1:2007
EN 55013:2001+A1:2003+A2:2006
EN 61000-3-2:2006+A1:2009+A2:2009
EN 61000-3-3:2008
EN 55024:1998+A1:2001+A2:2003
EN 55020:2007